

TYPE CHARTS / DESIGNATIONS OF SYMBOLS

	D41
	Z41a
	Z41b
	D42
	Z42a
	Z42b

CHARACTERISTICS oil viscosity $\nu = 30 \text{ mm}^2/\text{s}$

$Q = f(p)$ Volume flow-pressure-characteristics

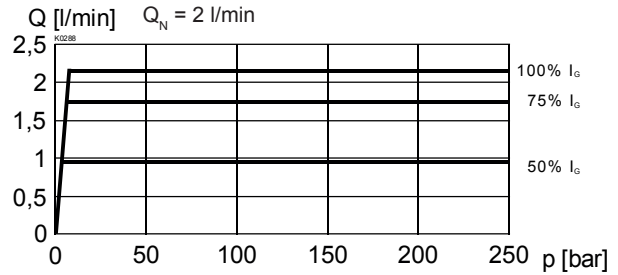

$Q = f(p)$ Volume flow-pressure-characteristics

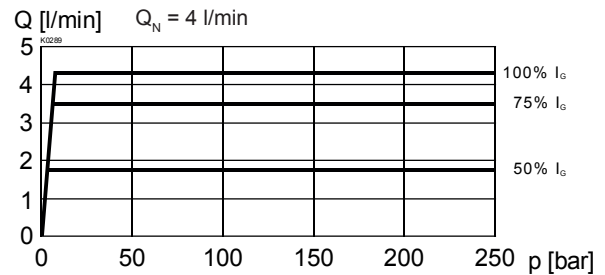

$Q = f(p)$ Volume flow-pressure-characteristics

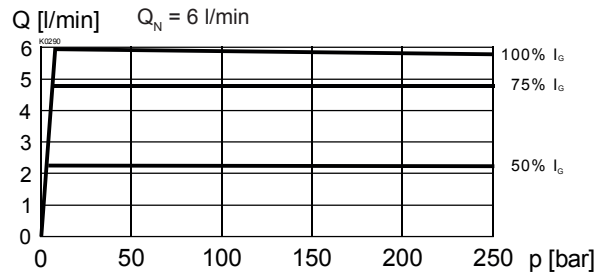

$Q = f(p)$ Volume flow-pressure-characteristics

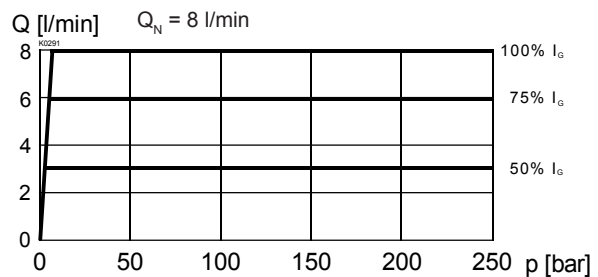

$Q = f(I)$ Volume flow-signal-characteristics

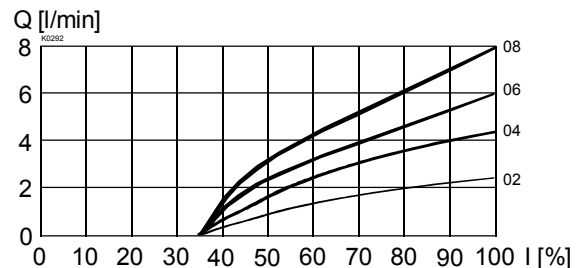

DIMENSIONS

4/3-way valve

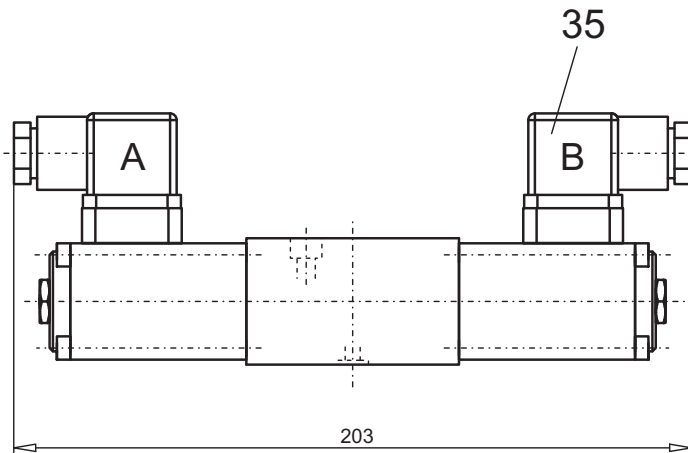

4/2-way valve

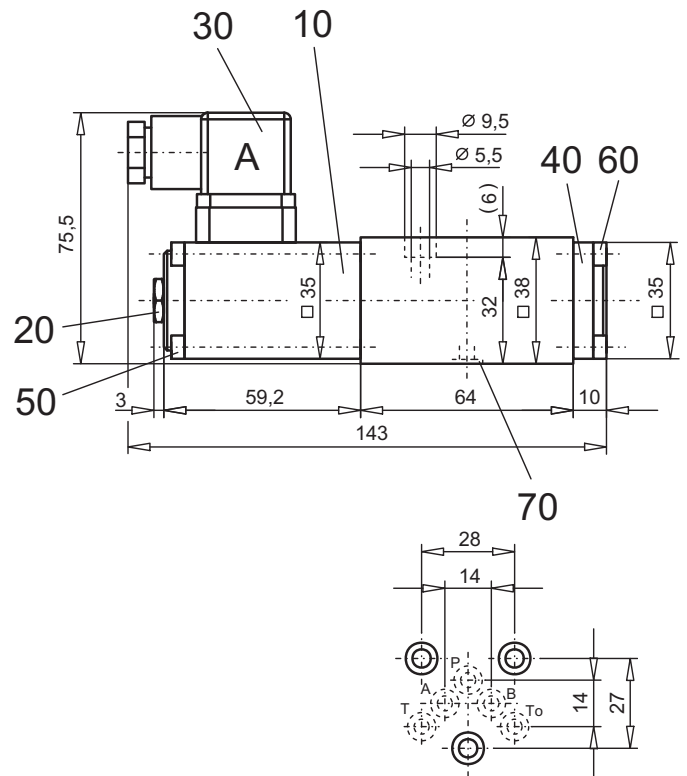
PARTS LIST

Position	Article	Description
10	256.3454 256.3426	Proportional solenoid PI35V-G24 Proportional solenoid PI35V-G12
20	253.8000	Plug with integrated manual override HB4,5
30	219.2001	Plug A (grey)
35	219.2002	Plug B (black)
40	057.4208	Cover
50	246.1161	Socket head cap screw M4x60 DIN 912
60	246.1111	Socket head cap screw M4x10 DIN 912
70	160.2052	O-ring ID 5,28x1,78

ACCESSORIES

Sub-plates	register 2.9
Proportional-amplifier	register 1.13

Technical explanation see data sheet 1.0-100