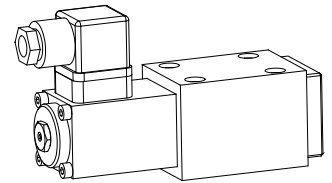

Proportional directional valve

- pressure compensated
- $Q_{max} = 20 \text{ l/min}$
- $p_{max} = 250 \text{ bar}$

NG6
 ISO 4401-03

DISCRIPTION

Directly controlled spool valve, actuated by a Wandfluh proportional solenoid (VDE standard 0580), in five chamber design. Wet solenoid in oil. Spools with precision machined oil passages control the oil volume wich is proportional to the solenoid current. Reduced pressure drop achieved by optimised flow channels. Precise spool fit, long life. Spool made of hardened steel, valve body made of high quality cast iron suitable for hydraulic valves. Flange type, threaded connection by means of a connecting plate.

FUNCTION

Spool stroke, aperture and volume flow increase proportionally to the increase in the electric current at the proportional solenoid. This special design senses and compensates load induced flow changes. Flow remains constant with varying pressure. The optimised shape of the spool results in a good resolution of flow important for sensitive motion control. To control the valve Wandfluh proportional amplifiers are available (see register 1.13).

APPLICATION

Because of the high resolution and low hysteresis, these valves are particularly suitable for demanding tasks. Applications: handling operations, robots, actuators, radar controlled vehicles, tool making and paper production machines, in other words anywhere where precise control systems are needed.

CONTENT

GENERAL SPECIFICATIONS.....	1
HYDRAULIC SPECIFICATIONS.....	1
ELECTRICAL SPECIFICATIONS.....	2
TYPE CHARTS / DESIGNATIONS OF SYMBOLS.....	2
CHARACTERISTICS.....	2/3
DIMENSIONS.....	3
PARTS LIST.....	4
ACCESSORIES.....	4

TYPE CODE

WVS 4 - - TF - #

Proportional control valve

Number of control ports

Symbol type see chart on page 1.10-11/2

Nominal volume flows:

$Q_N = 2,5 \text{ l/min}$	<input type="checkbox"/> 2,5	$Q_N = 10 \text{ l/min}$	<input type="checkbox"/> 10
$Q_N = 5 \text{ l/min}$	<input type="checkbox"/> 05	$Q_N = 15 \text{ l/min}$	<input type="checkbox"/> 15
$Q_N = 20 \text{ l/min}$	<input type="checkbox"/> 20		

Normally closed

Standard nominal voltage U_N : 12 VDC G12
 24 VDC G24

Design-Index (Subject to change)

GENERAL SPECIFICATIONS

Nominal size	NG6 acc. to ISO 4401-03
Designation	4/2-, 4/3-way proportional control valve
Construction	Direct operated spool valve
Mounting	Flange, 4 holes for socket cap screws M5 x 45
Fastening torque	$M_D = 5,5 \text{ Nm}$ (screw quality 8.8)
Pipe connection	Connection plates, Multi-station flange subplate, Longitudinal stacking system
Mounting position	any
Ambient temperature	-20...+50 °C
Weight: 4/2-way	m = 1,85 kg
4/3-way	m = 2,85 kg

HYDRAULIC SPECIFICATIONS

Fluid	Mineral oil, other fluid on request	
Contamination efficiency	ISO 4406:1999, class 18/16/13 (Required filtration grade $\beta_{6...10} \geq 75$) refer to data sheet 1.0-50/2	
Viscosity range	12 mm ² /s...320 mm ² /s	
Fluid temperature	-20...+70 °C	
Working pressure	$p_{max} = 250 \text{ bar}$ (Ports P, A, B)	
Tank pressure	max tank pressure in T	
	$p_{max} = 160 \text{ bar}$	
Nominal volume flows	$Q_N = 2,5 \text{ l/min}$	$Q_N = 10 \text{ l/min}$
	$Q_N = 5 \text{ l/min}$	$Q_N = 15 \text{ l/min}$
	$Q_N = 20 \text{ l/min}$	
Min. volume flow	$Q_{min} = 0,02 \text{ l/min}$	
Leakage volume flow	on request	
Resolution	1 mA *	
Repeatability	≤ 1% *	
Hysteresis	≤ 2% *	
	* by optimal dithersignal	

ELECTRICAL SPECIFICATIONS

Construction Proportional solenoid, wet pin push type, pressure tight.

Standard-Nominal voltage	U = 12 VDC	U = 24 VDC	
Limiting current: PI35V	$I_G = 1250 \text{ mA}$	$I_G = 680 \text{ mA}$	for VWS4.61 $Q_N 2,5 \dots 10 \text{ l/min}$ for VWS4.62 $Q_N 2,5 \dots 10 \text{ l/min}$
PI45V	$I_G = 1780 \text{ mA}$	$I_G = 810 \text{ mA}$	for VWS4.61 $Q_N 15 \dots 20 \text{ l/min}$ for VWS4.62 $Q_N 15 \dots 20 \text{ l/min}$

Relative duty factor 100% DF (see data sheet 1.1-430)
 Protection class IP65 to EN 60529
 Connection/Power Over device plug connection to supply
 ISO 4400/DIN 43650 (2P+E)
 Other electrical specifications see data sheet: 1.1-115 (PI35V)
 1.1-130 (PI45V)

TYPE CHARTS/DESIGNATIONS OF SYMBOLS

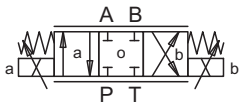
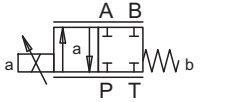
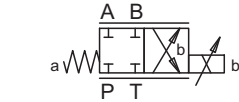
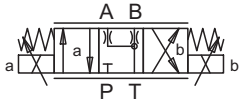
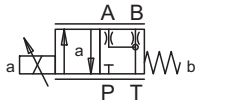
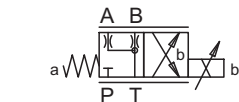
	D61
	Z61a
	Z61b
	D62
	Z62a
	Z62b

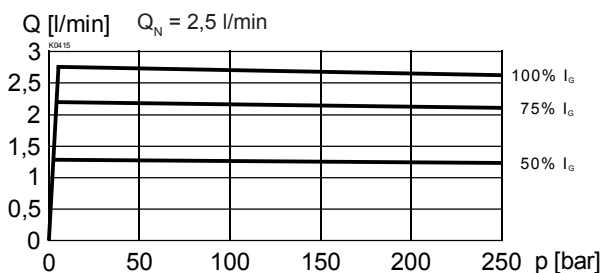
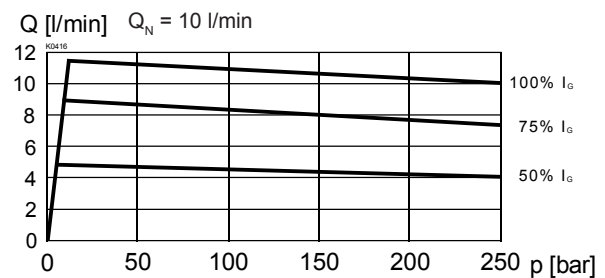
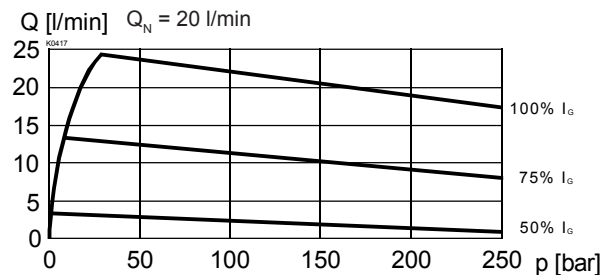
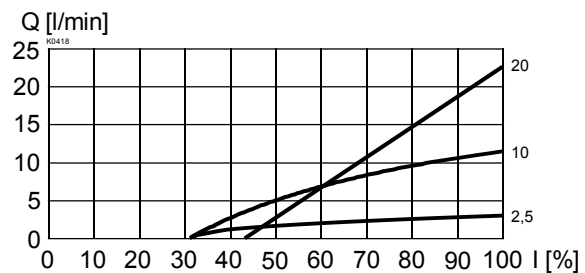
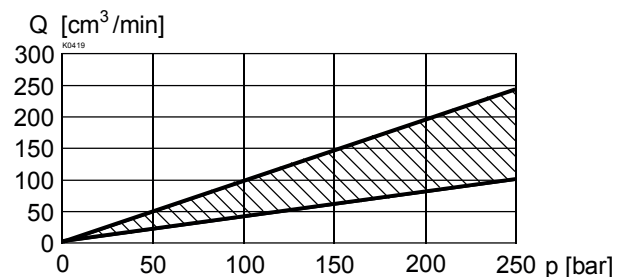
CHARACTERISTICS oil viscosity $\nu = 30 \text{ mm}^2/\text{s}$
 $Q = f(p)$ Volume flow-pressure-characteristics

 $Q = f(p)$ Volume flow-pressure-characteristics

 $Q = f(p)$ Volume flow-pressure-characteristics

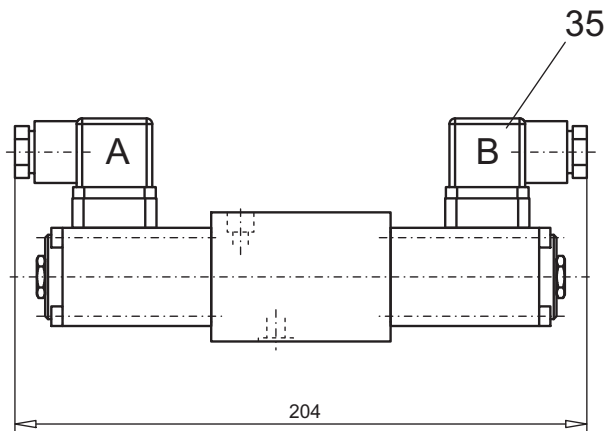
 $Q = f(I)$ Volume flow-signal-characteristics

 $Q_L = f(p)$ Leakage volume flow characteristics per control edge

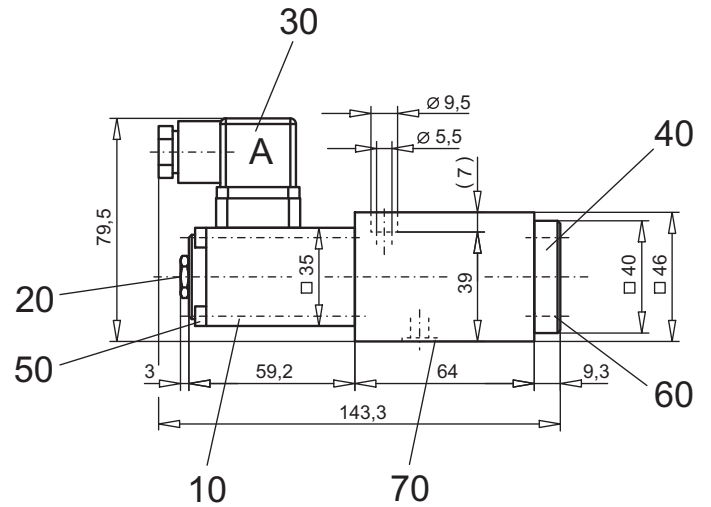
DIMENSIONS

4/3-way valve VWS4.61 for Q_N 2,5...10 l/min
4/3-way valve VWS4.62 for Q_N 2,5...10 l/min



4/2-way valve VWS4.61 for Q_N 2,5...10 l/min
4/2-way valve VWS4.62 for Q_N 2,5...10 l/min



4/3-way valve VWS4.61 for Q_N 15...20 l/min
4/3-way valve VWS4.62 for Q_N 15...20 l/min

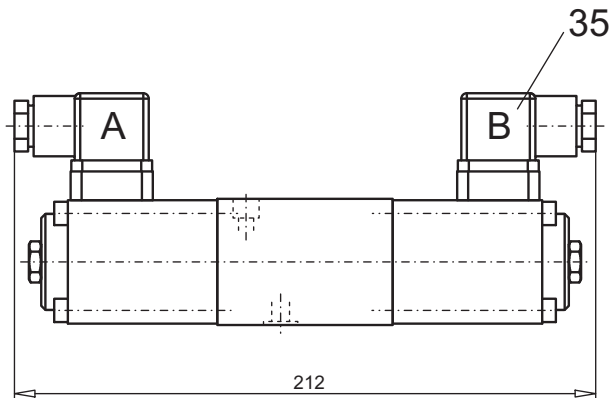

4/2-way valve VWS4.61 for Q_N 15...20 l/min
4/2-way valve VWS4.62 for Q_N 15...20 l/min

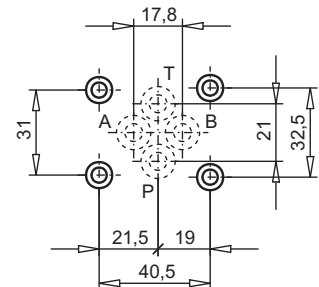
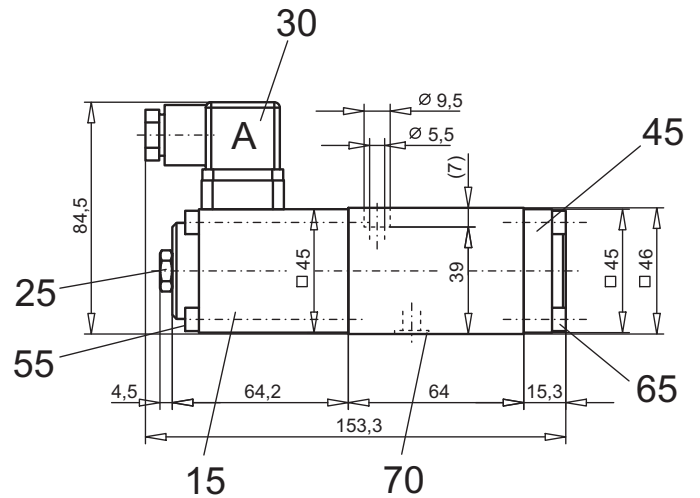

PARTS LIST

Position	Article	Description
10	256.3454	Proportional solenoid PI35V-G24
	256.3426	Proportional solenoid PI35V-G12
15	256.4454	Proportional solenoid PI45V-G24
	256.4418	Proportional solenoid PI45V-G12
20	253.8000	Plug with integrated manual override HB4,5
25	253.8001	Plug with integrated manual override HB6
30	219.2001	Plug A (grey)
35	219.2002	Plug B (blac)
40	060.2200	Cover
45	058.4100	Cover
50	246.1161	Socket head cap screw M4 x60 DIN 912
55	246.2160	Socket head cap screw M5 x60 DIN 912
60	246.1111	Socket head cap screw M4 x 10 DIN 912
65	246.2117	Socket head cap screw M5 x 16 DIN 912
70	160.2093	O-ring ID 9,25 x 1,78

ACCESSORIES

Sub-plates	register 2.9
Proportional-amplifier	register 1.13

Explications techniques voir feuille 1.0-100